

DF300 Shrink Sleeve Applicator



Features

- The DF Shrink Sleeve Applicator applies Tamper Evident sleeves.
- Shrink sleeve labels applied to filled containers made of the most popular sustainable plastics including Metal and Glass.
- For use with PETG, PETC, RPET, PO, OPS, Hybrid, PVC, PLA material 40 to 70 microns thick.
- Two modularly guillotine cutting units are available for products between (30mm – 100mm), (30 – 125mm).
- Toolless mechanical adjustment.
- Servo controlled.
- Next generation Smartlink™ HMI.
- Speeds up to 300 containers per minute.

DF300 SHRINK SLEEVE APPLICATOR

In an ever-evolving shrink sleeve marketplace where the focus is on sustainability and label down gauging, the DF Shrink Sleeve Applicator is designed to handle the latest label technology, with a modular design to offer flexibility to scale, based on your business needs.

The DF Shrink Sleeve Applicator is ergonomically designed to focus on safety, ease of use, productivity, and performance while optimizing a minimal footprint.

Improve output, ease changeovers, simplify operations, and reduce maintenance costs, all while improving shrink sleeve label appearance!

The comprehensive range of Accraply ancillary modules along with Accraply's range of Hot Air (Convection) and IR (Infra-Red) heat tunnels can be incorporated with DF Shrink Sleeve Applicator providing a totally integrated solution.

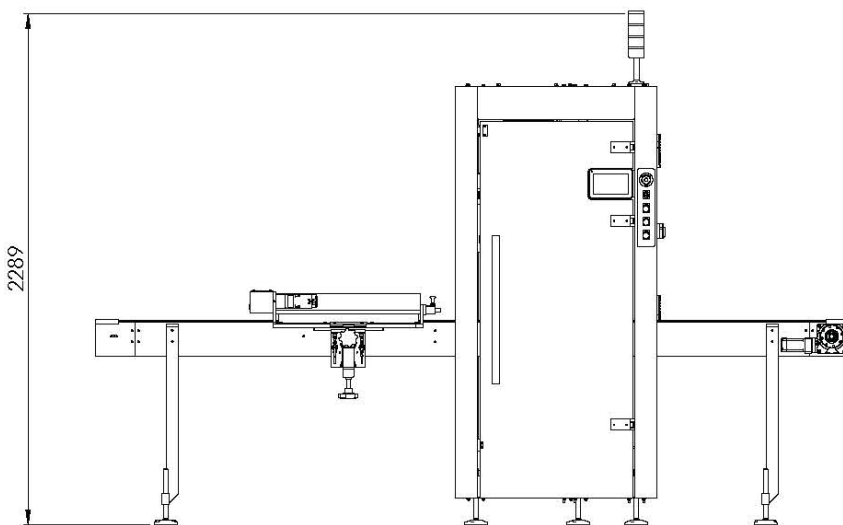
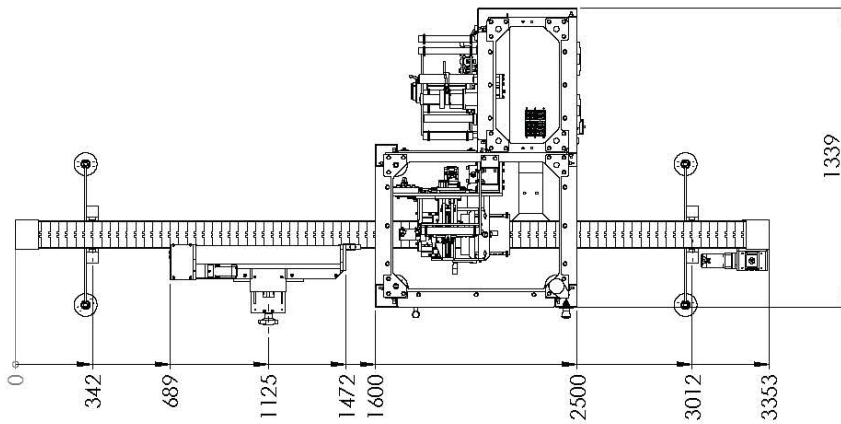
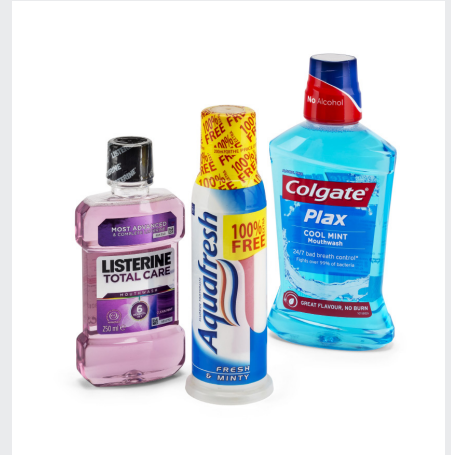

Product Diameter	(170mm width Guillotine) 30mm - 100mm (210 width Guillotine) 30mm - 125mm
Sleeve Length	30mm - 50mm
Maximum Speed	300ppm @ 30mm cut-length
Film Type	PETG, PETC, REPT, PO, OPS, Hybrid, PVC, PLA
Film Thickness	40 - 70 microns
Maximum Unwind Diameter	350mm OD
Unwind Core Diameter	127mm (5")
Machine Weight	250 KG
Conveyor Height	900 - 1000mm
Air Requirements	80 PSI 5 bar/0.2cu M/MIN
Electrical Requirements	380v - 415 Vac 3 Phase + Neutral + Earth 20A

** All specification and tooling requirements are subject to Accraply evaluation of all label and product samples. Specifications shown reflect standard machine capabilities. Accraply can also meet other specification requirements. Please call for details.*

Accraply | Trine | Stanford | Graham & Sleevit | Harland

Accraply - United States

9350 W Broadway Avenue, Ste 190
Minneapolis, MN 55445 USA
+1 (763) 557-1313

Accraply - Canada

3070 Mainway
Burlington, ON L7M3X1
+1 (905) 336-8880

Accraply - United Kingdom

Northbank Industrial Estate, Gilchrist Rd
Irlam, Manchester M44 5AY
+44 161 848 4800

accraply.com
info@accraply.com

